

W414/W414A

HIGH VOLTAGE, PHOTO MOS RELAY

COSMO

FEATURES

- Normally Close, Single Pole Single Throw
- Control 400VAC or DC Voltage
- Switch 130mA Loads
- LED control Current, 5mA
- Low ON-Resistance
- $dv/dt, >500V/ms$
- Isolation Test Voltage, 3750VACrms

Absolute Maximum Ratings($T_a=25^\circ C$)

Emitter(Input)

Reverse Voltage	5.0V
Continuous Forward Current	50mA
Peak Forward Current	1A
Power Dissipation	100mW
Derate Linearly from 25°C	1.3mW/°C

Detector(Output)

Output Breakdown Voltage	$\pm 400V$
Continuous Load Current	$\pm 130mA$
Power Dissipation	500mW

General Characteristics

Isolation Test Voltage	3750VACrms
Isolation Resistance $V_{io}=500V, T_a=25^\circ C$	$\geq 10^{10} \Omega$
Total Power Dissipation	550mW
Derate Linearly from 25°C	2.5mW/°C
Storage Temperature Range	-40°C to +125°C
Operating Temperature Range	-30°C to +85°C
Junction Temperature	100°C
Soldering Temperature, 2mm from case, 10 sec	260°C

• Operate/Reverse time

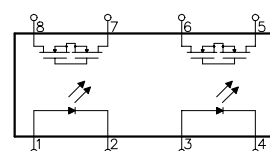
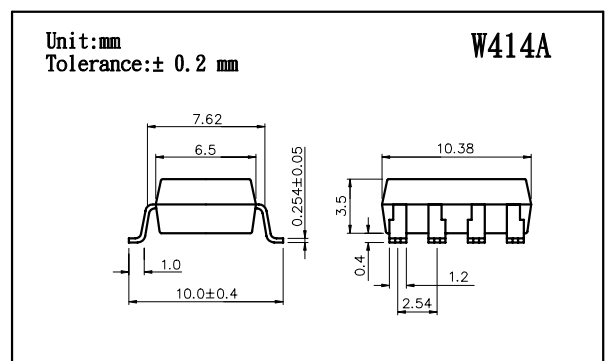
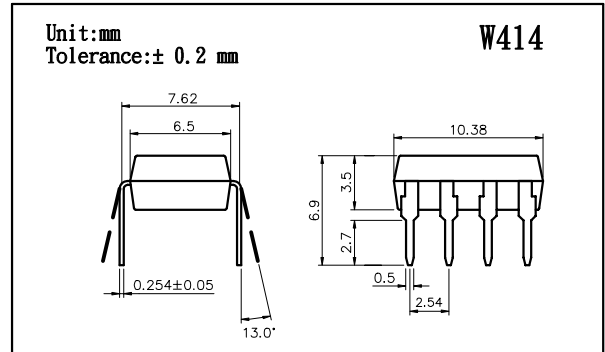
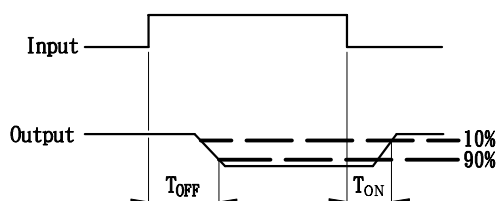

DUAL 1 FORM B
NORMALLY CLOSE

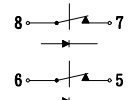

W414/W414A

HIGH VOLTAGE, PHOTO MOS RELAY

Characterisitcs

(Ta=25°C)

Description	Symbol	Min.	Typ.	Max.	Unit	Test Condition
Emitter(Input)						
Forward Voltage	VF		1.8	2.0	V	IF=10mA
Operation Input Current	I _{FOFF}			5	mA	VL=± 20V, IL<=5uA
Recovery Input Current	I _{FON}	0.2			mA	VL=± 20V, IL=100mA t=10mS
Detector (output)						
Output Breakdown Voltage	VB	400			V	IB=50uA
Output Off-State Leakage	IT(OFF)		0.2	2	uA	VT=100V, IF=10mA
I/O Capacitance	CISO		6		pF	IF=0, f=1MHz
ON Resistance	RON		40	50	Ω	IL=100mA, IF=0mA
Reverse(ON) Time	TON		0.6	1.5	ms	IF=10mA, VL=± 20V
Operate(OFF) Time	TOFF		0.3	1.0	ms	t=10ms, IL=± 100mA

Mos Relay Schematic and Wiring Diagrams

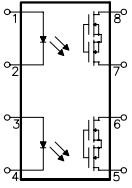
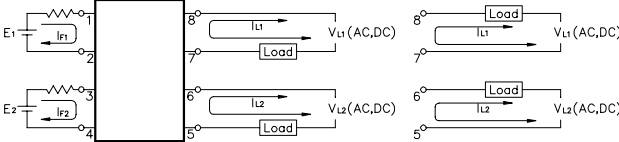
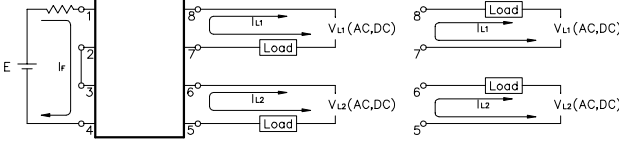
Type	Schematic	Output configuration	Load	Con- nection	Wiring Diagrams
W414 & W414A		2b	AC/DC	-	<p>(1)Two independent 1 Form B use</p>  <p>(2)2 Form B use</p> 

DATA CURVE

Load current vs. ambient temperature
Allowable ambient temperature:
-40°C to +85°C

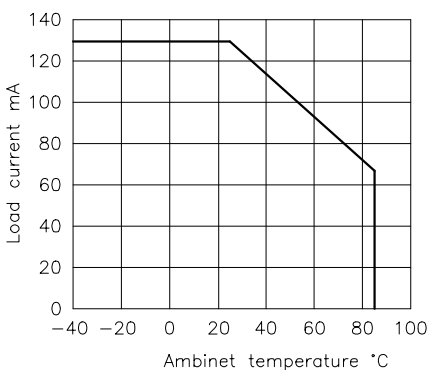

On resistance vs. ambient temperature
Across terminals 5,7 and 6,8 pin
LED current: 0mA
Continuouse load current: 130mA(DC)

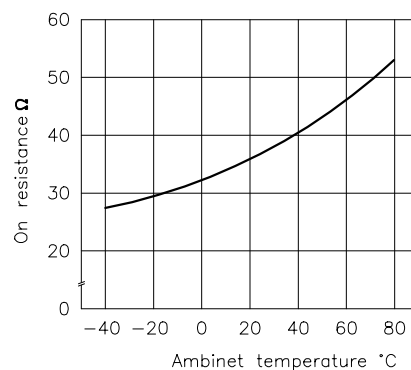

Operate(OFF) time vs. ambient temperature
Load voltage 400V(DC)
LED current: 5mA
Continuouse load current: 130mA(DC)

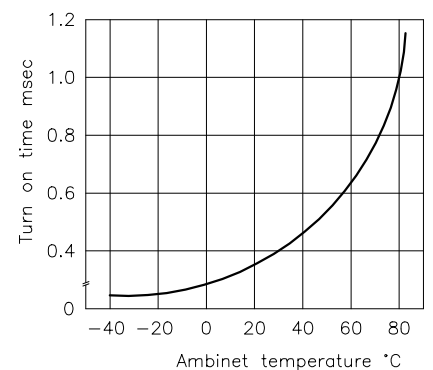

W414/W414A

HIGH VOLTAGE, PHOTO MOS RELAY

W414/W414A

Reverse(ON) time vs. ambient temperature
LED current: 5mA; Load voltage: 400V(DC)
Continuous load current: 130mA(DC)

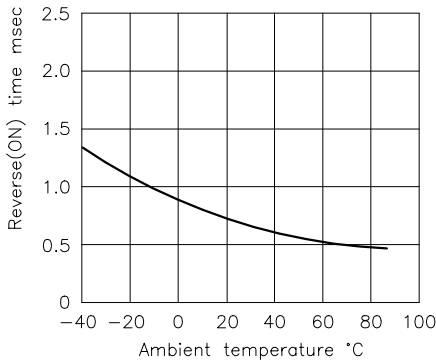

LED operate(OFF) vs. ambient temperature
Load voltage: 400V(DC)
Continuous load current: 130mA(DC)

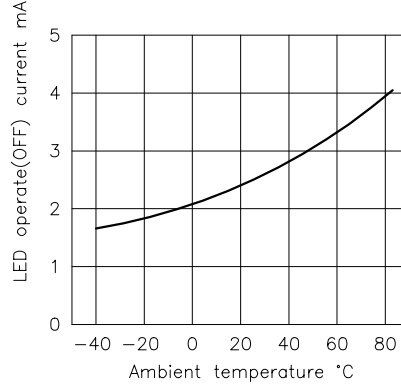

LED reverse(ON) current vs. ambient temperature
Load voltage: 400V(DC)
Continuous load current: 130mA(DC)

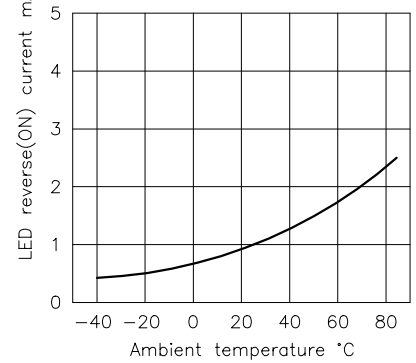

LED dropout voltage vs. ambient temperature
LED current: 5 to 50mA

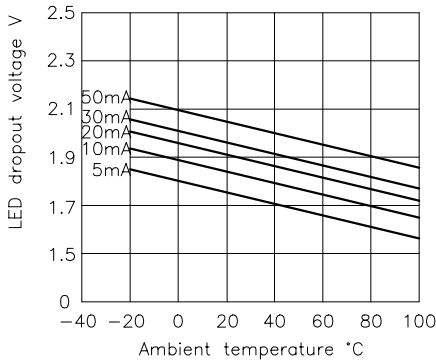

Voltage vs. current characteristics of output at MOS FET portion
Measured portion: across terminals 5,7 and 6,8 pin
Ambient temperature: 25°C

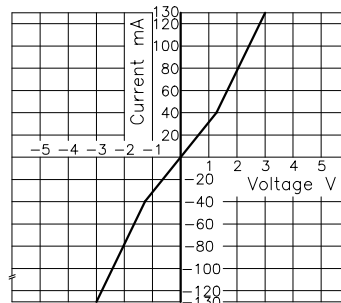

Off state leakage current
Across terminals 5,7 and 6,8 pin
Ambient temperature: 25°C

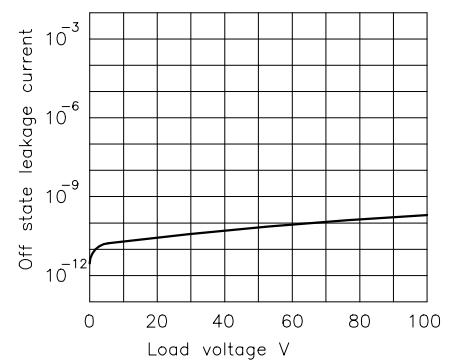

LED forward current vs. operate(OFF) time
Across terminals 5,7 and 6,8 pin; Load voltage: 400V(DC); Continuous load current: 130mA(DC); Ambient temperature: 25°C

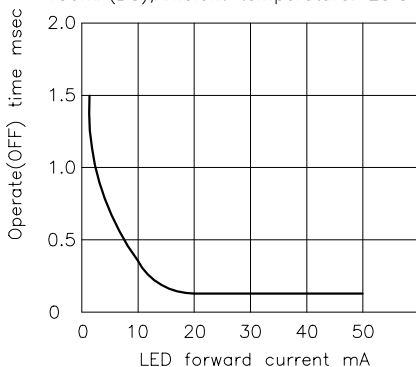

LED forward current vs. reverse(NO) time
Across terminals 5,7 and 6,8 pin; Load voltage: 400V(DC); Continuous load current: 130mA(DC); Ambient temperature: 25°C

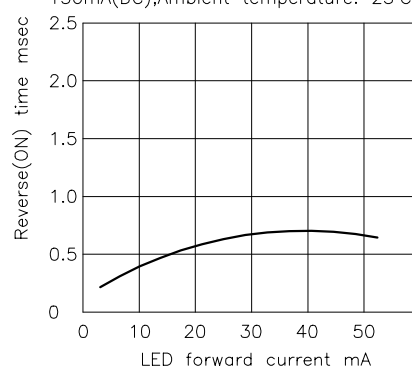

Applied voltage vs. output capacitance
Across terminals 5,7 and 6,8 pin
Frequency: 1MHz; Ambient temperature: 25°C

